

holes for assembling with Stage 2

0

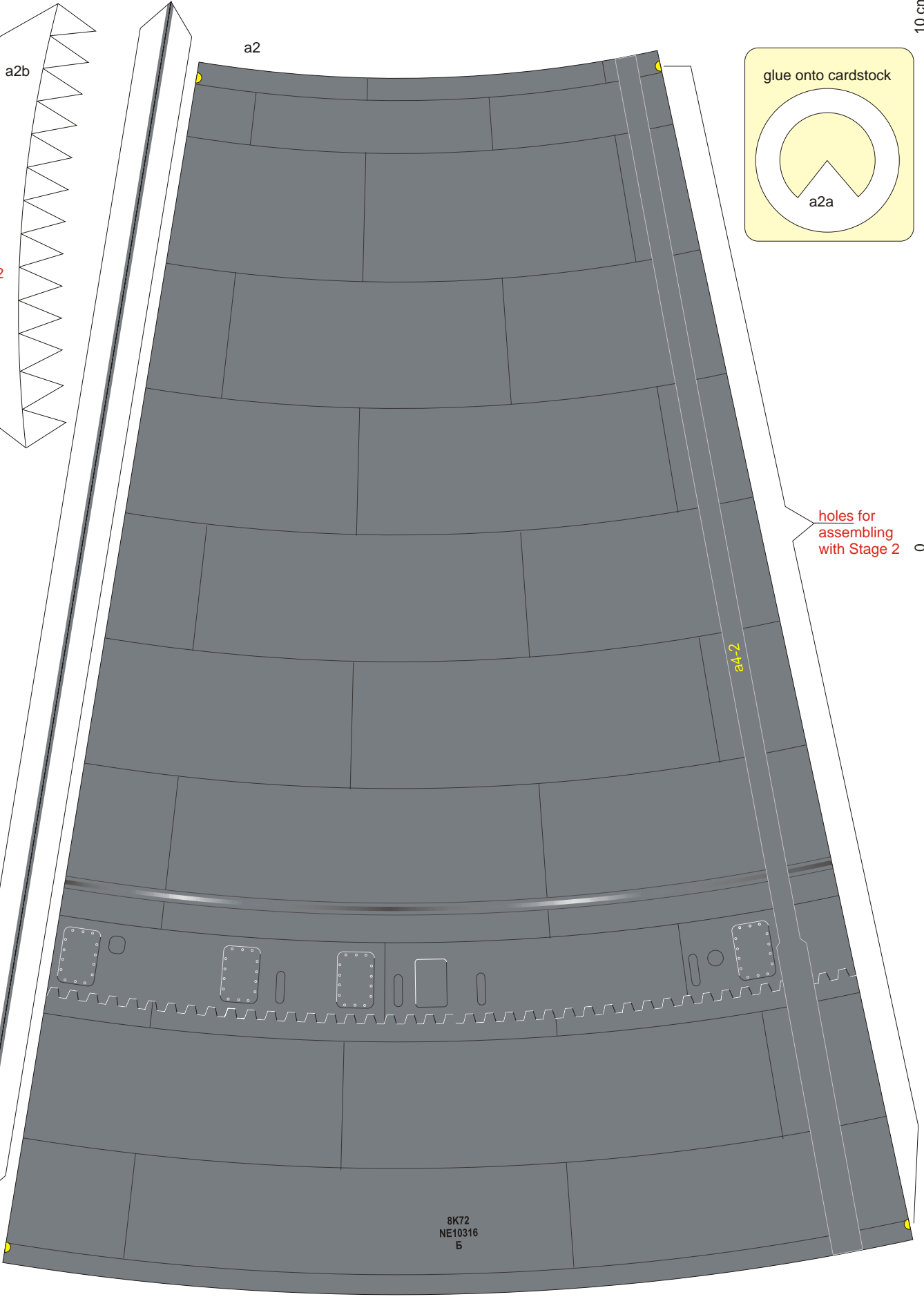

8K72
NE10316
Б

a4-2

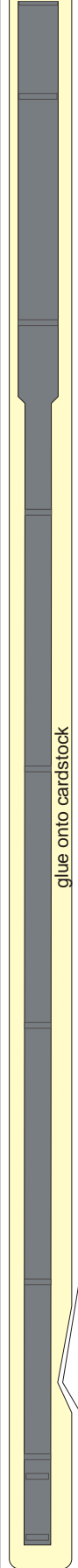

a2b

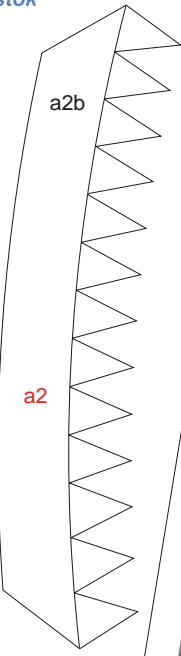

a2

a2

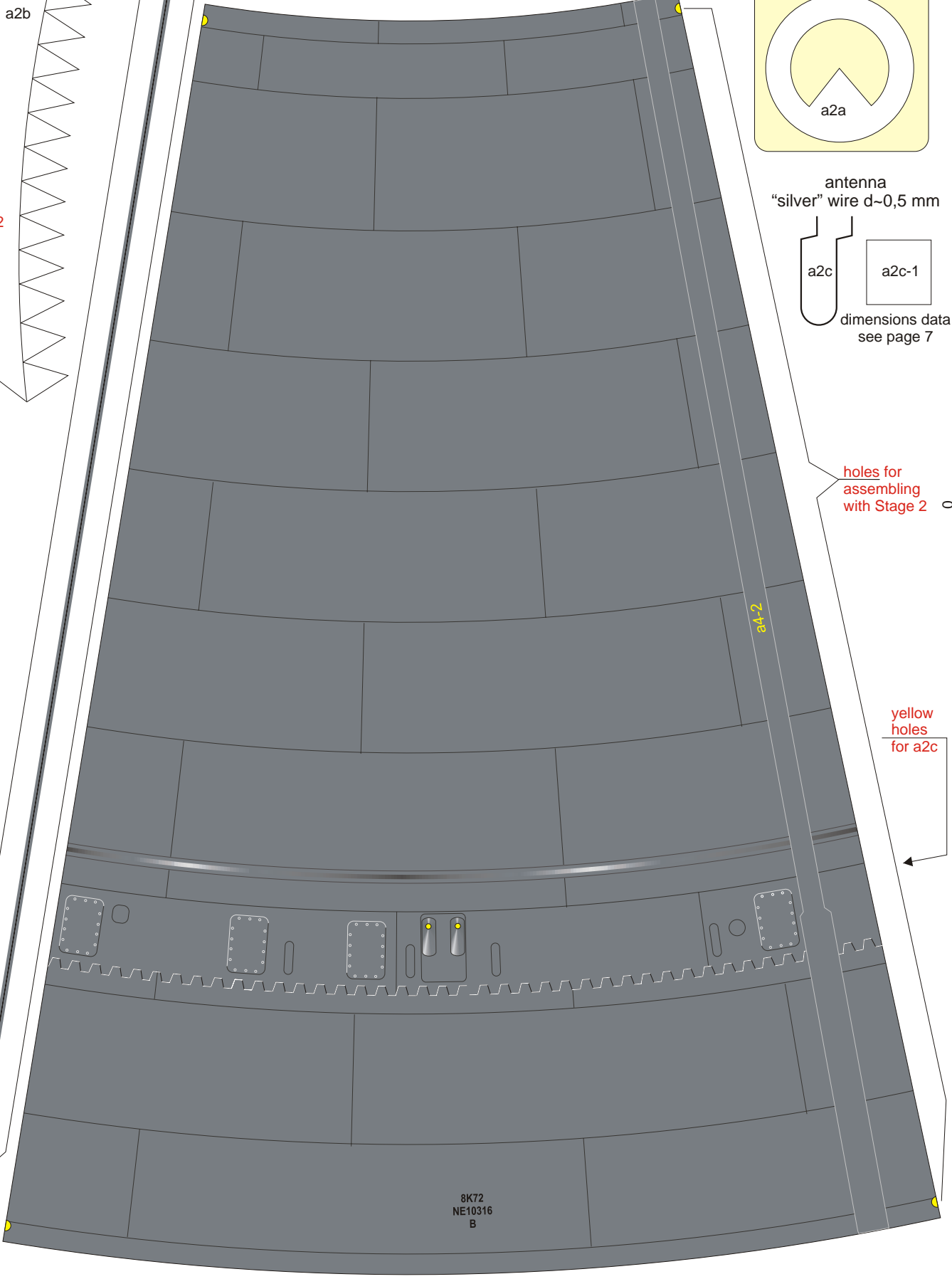

glue onto cardstock

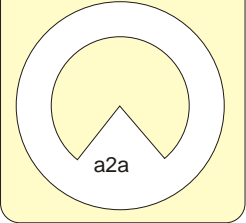

antenna
"silver" wire d~0,5 mm

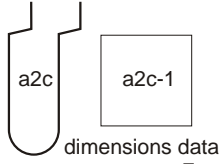

holes for
assembling
with Stage 2

yellow
holes
for a2c

8K72
NE10316
B

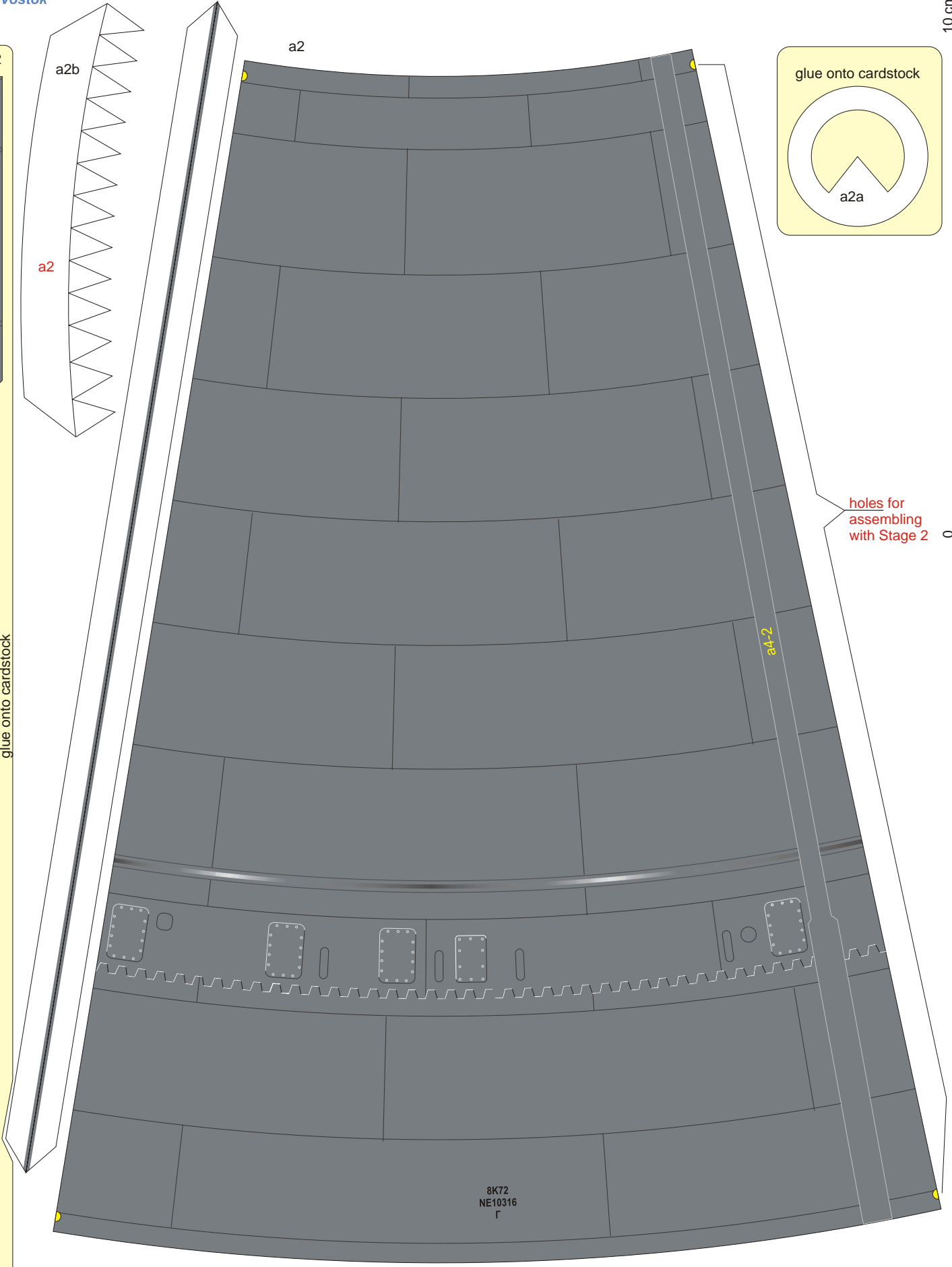
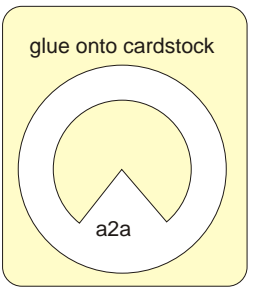
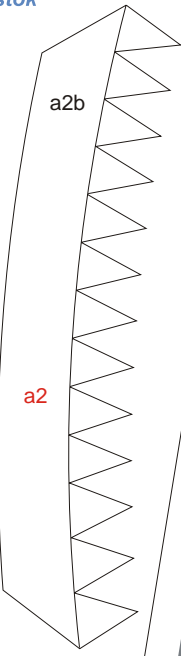
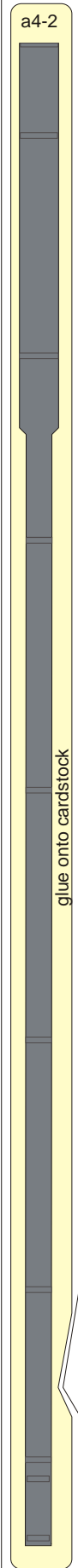

8K72
NE10316
Г

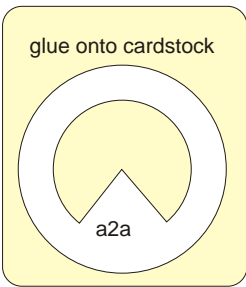
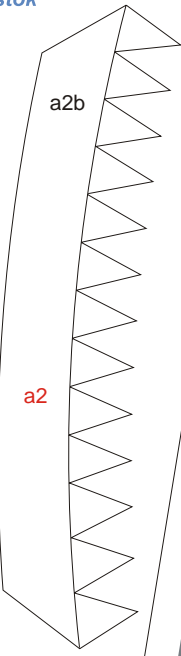
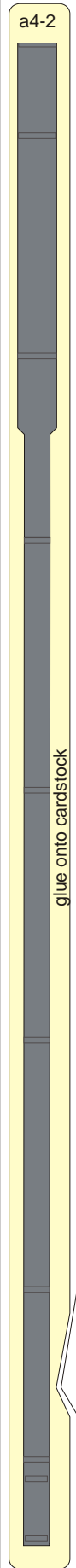

holes for assembling with Stage 2

0

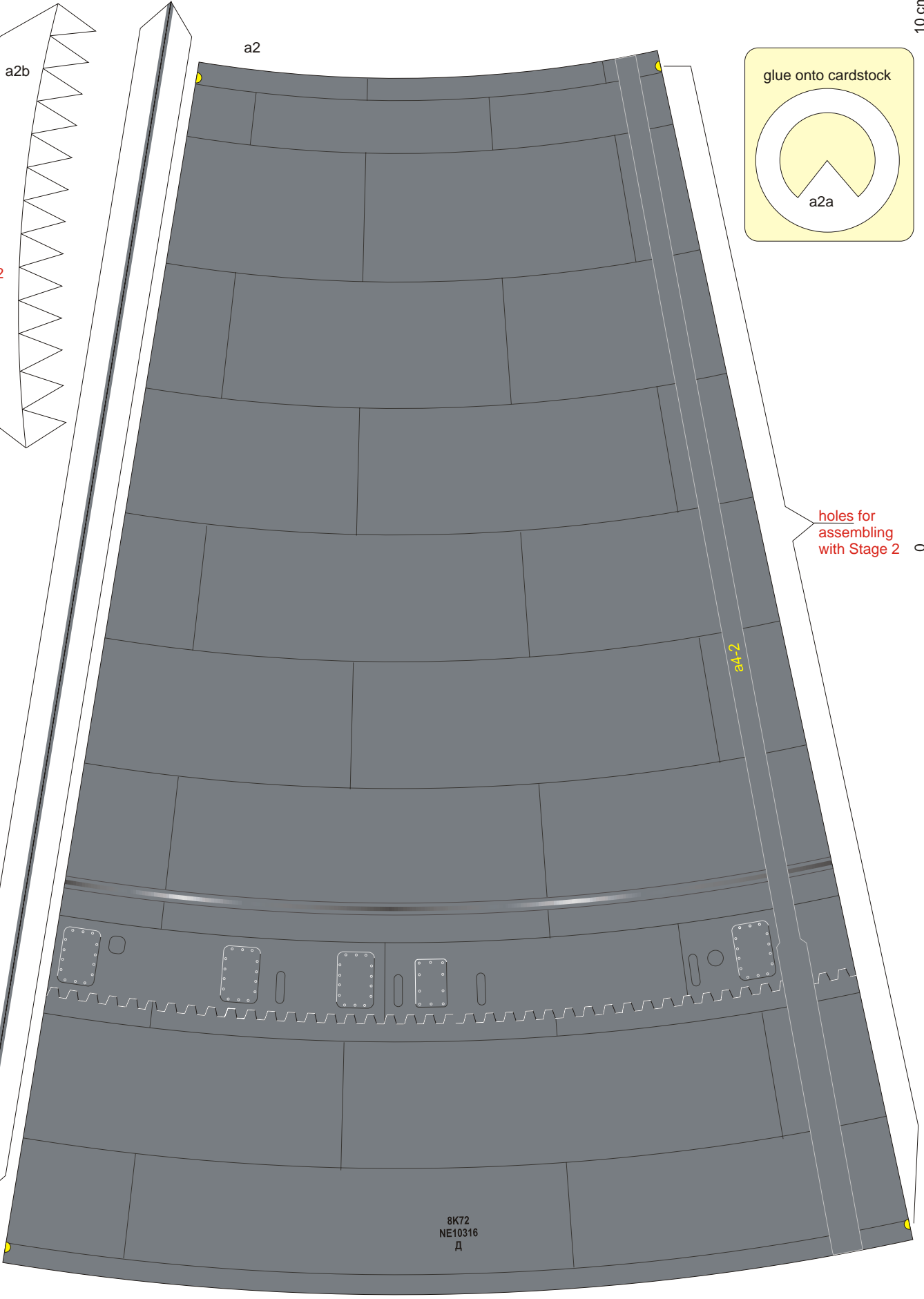

8K72
NE10316
Д

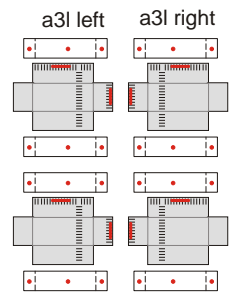
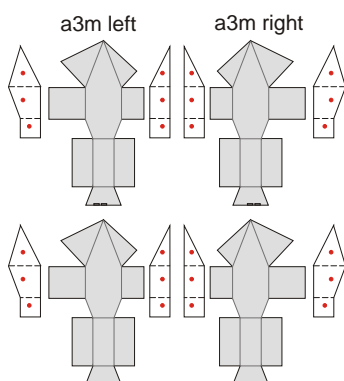
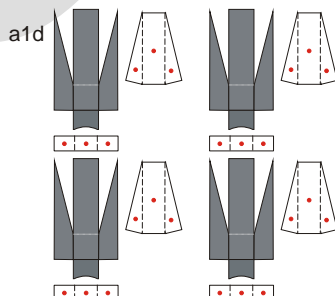
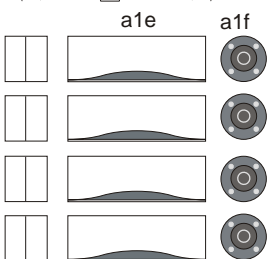
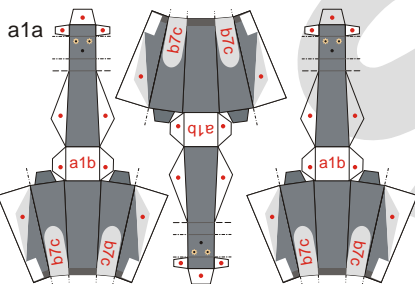
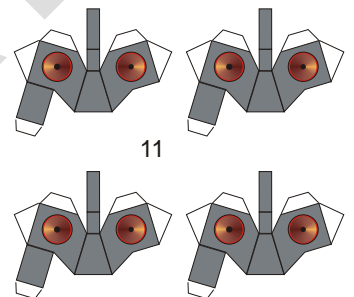
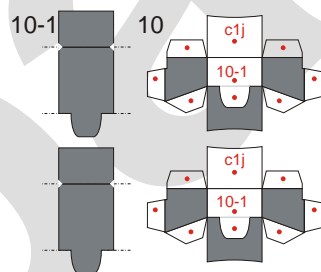
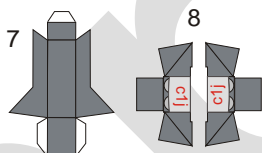
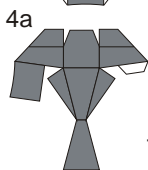
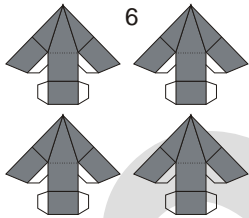
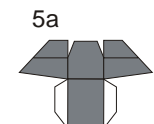
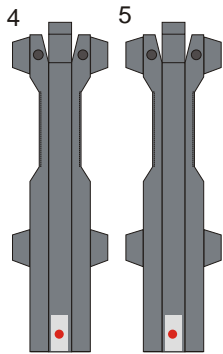
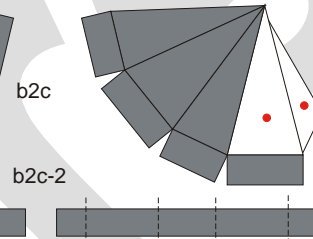
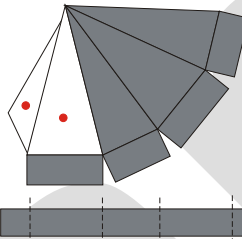
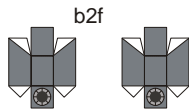
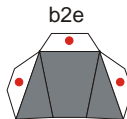
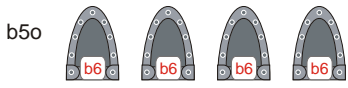
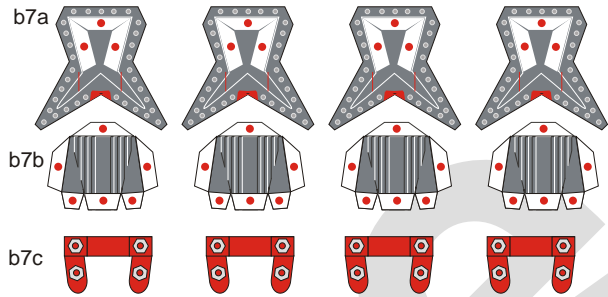
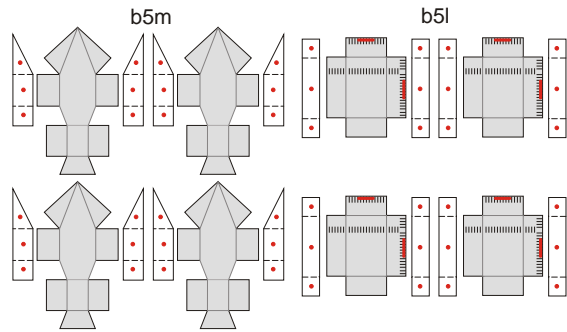
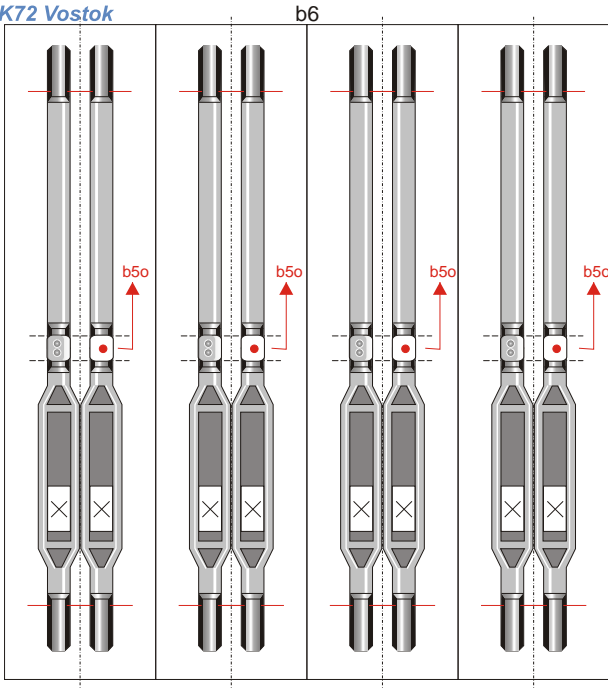

Assembling of Stage 3

Assembly steps

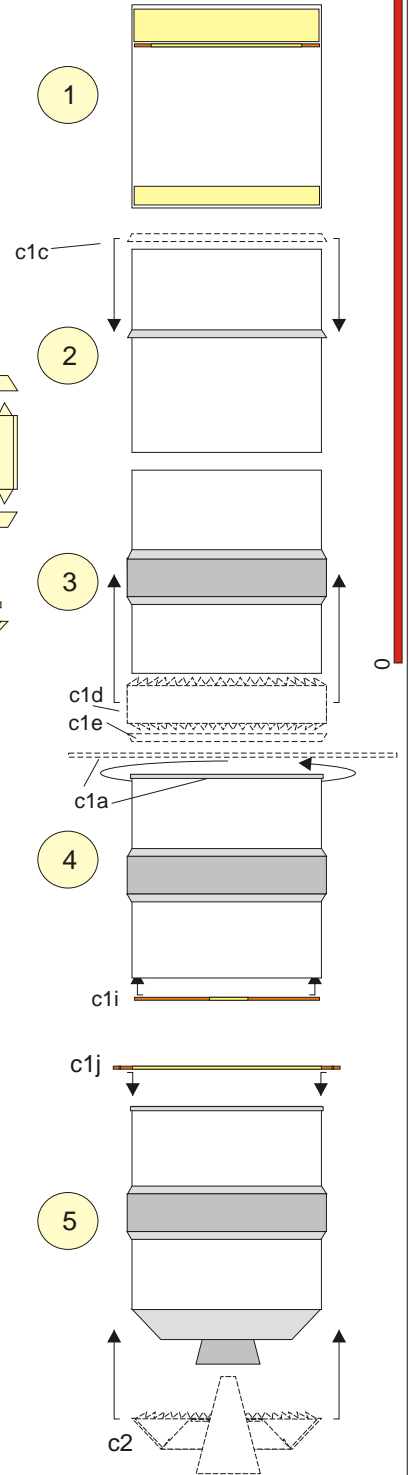
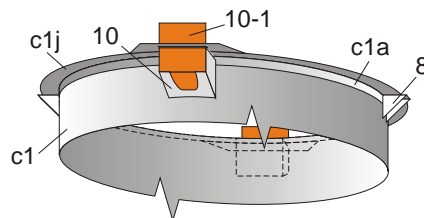
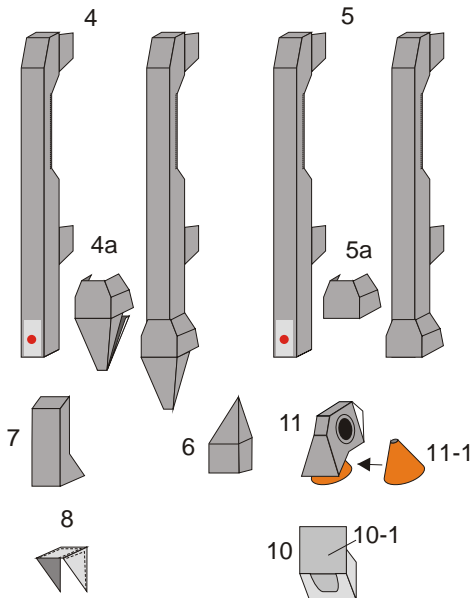
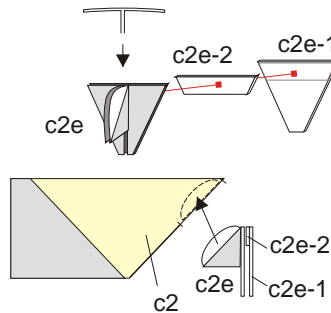
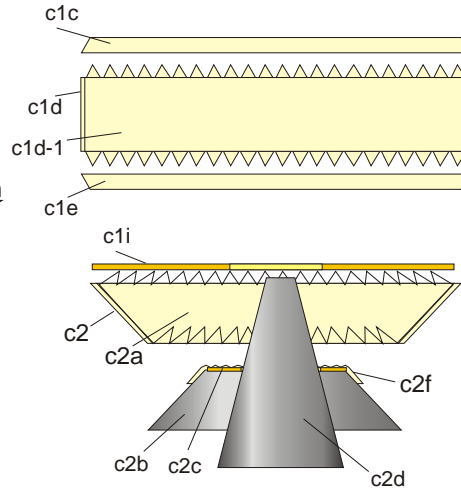
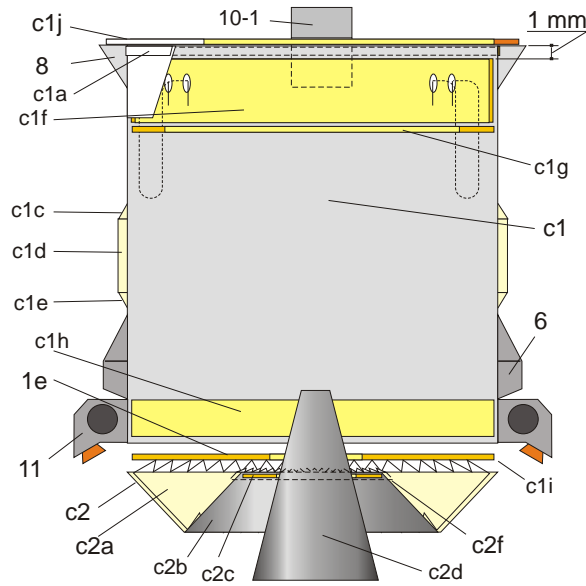
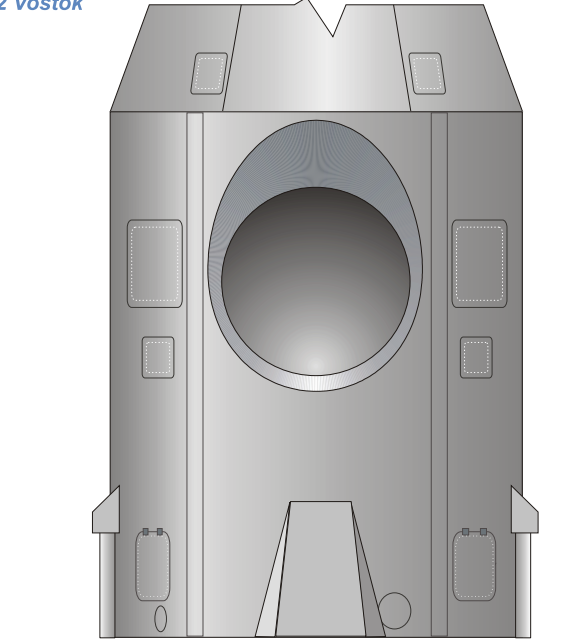

6 glue small parts

Assembling of Stage 1 and Stage 2

Stage 1 (1 of 4)

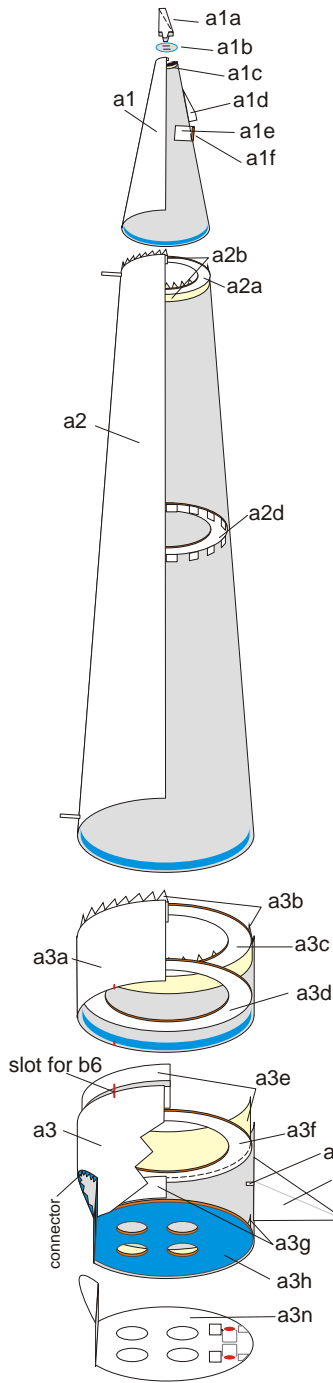

Height all of assebled parts a3 must be ~84 mm (without tabs of a3b) and identical.

Stage 2

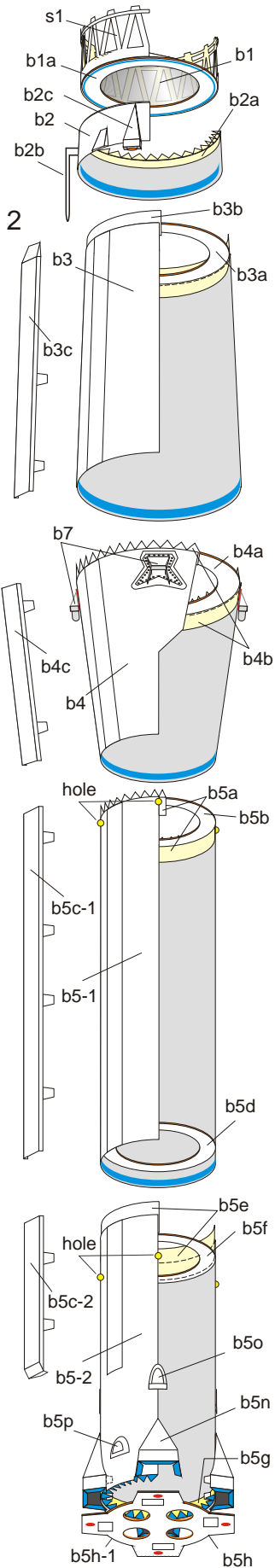

Mounting of Stage1 blocks onto Stage 2

