

1:96 scale

Lunar Orbiter Module

Project Energia

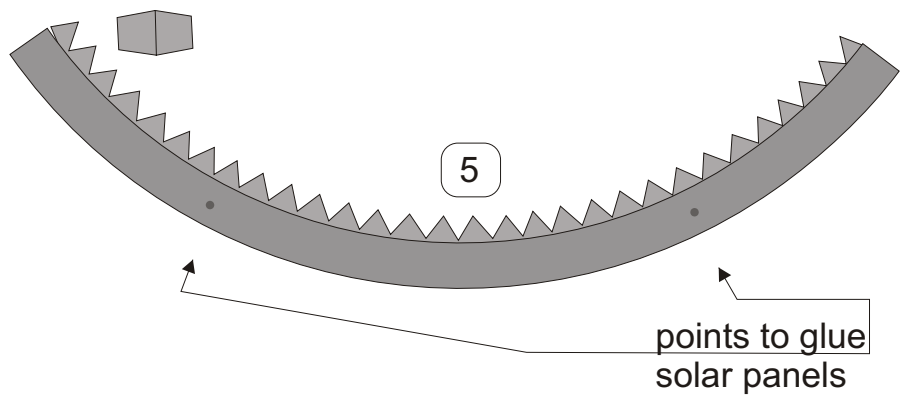

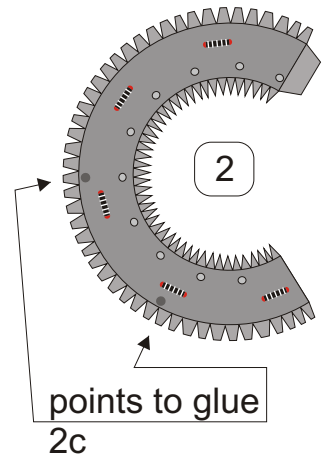
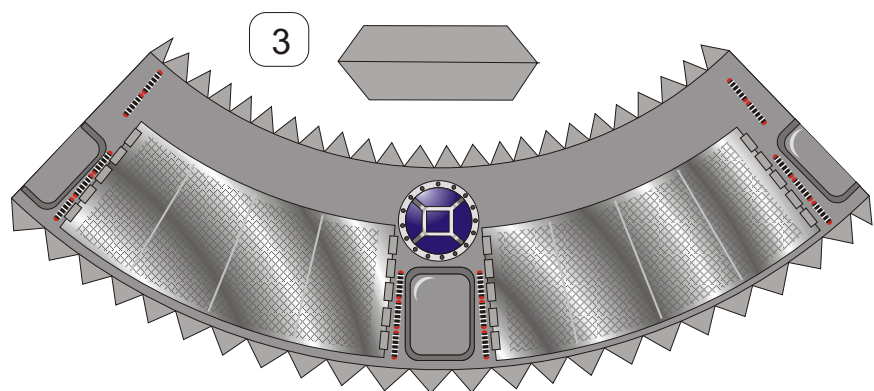
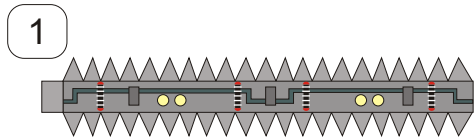
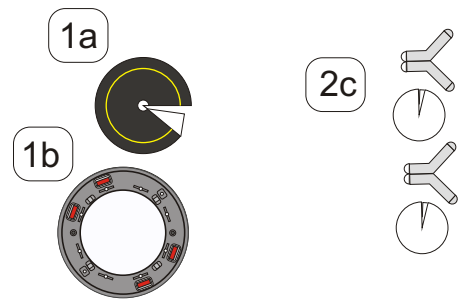
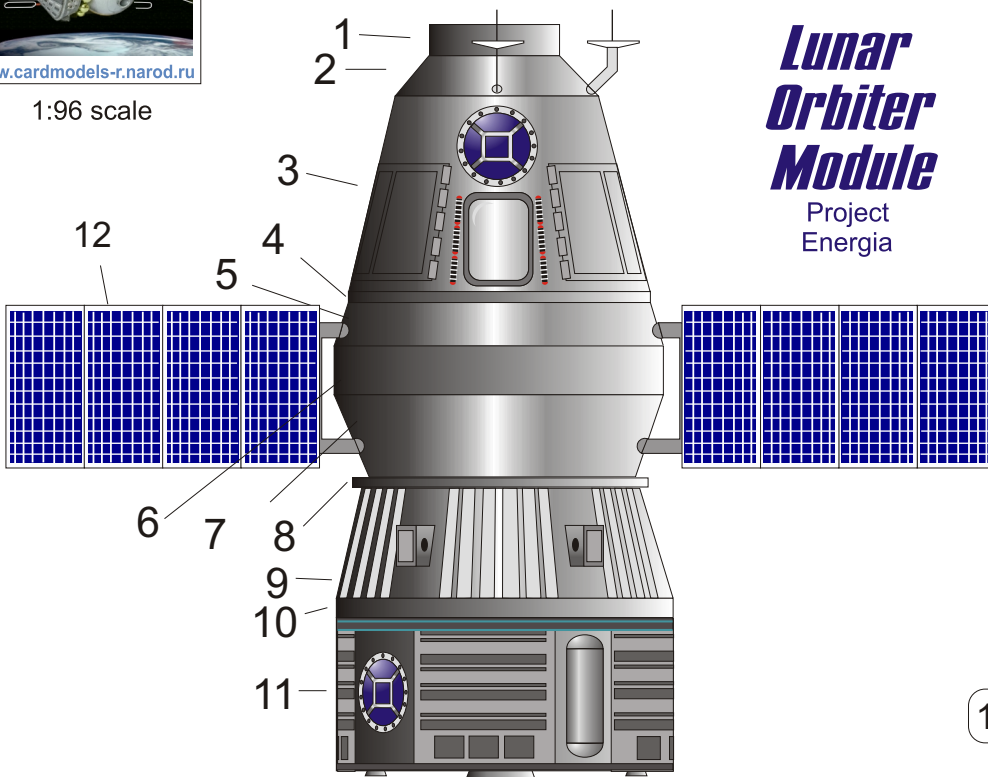
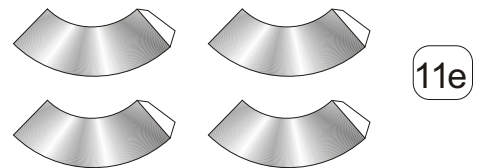
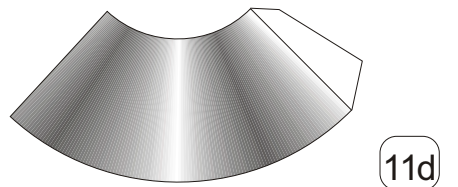
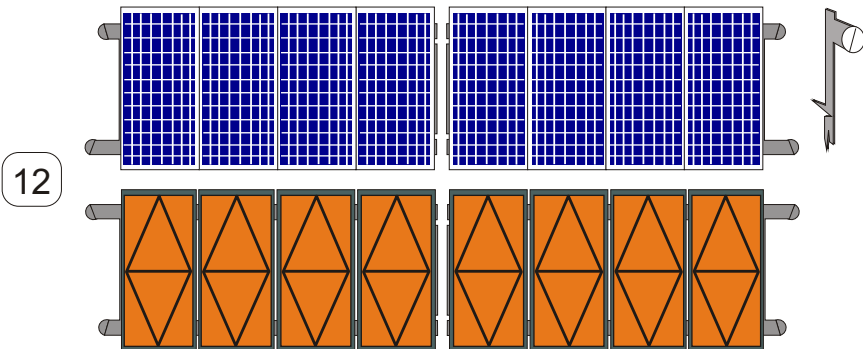
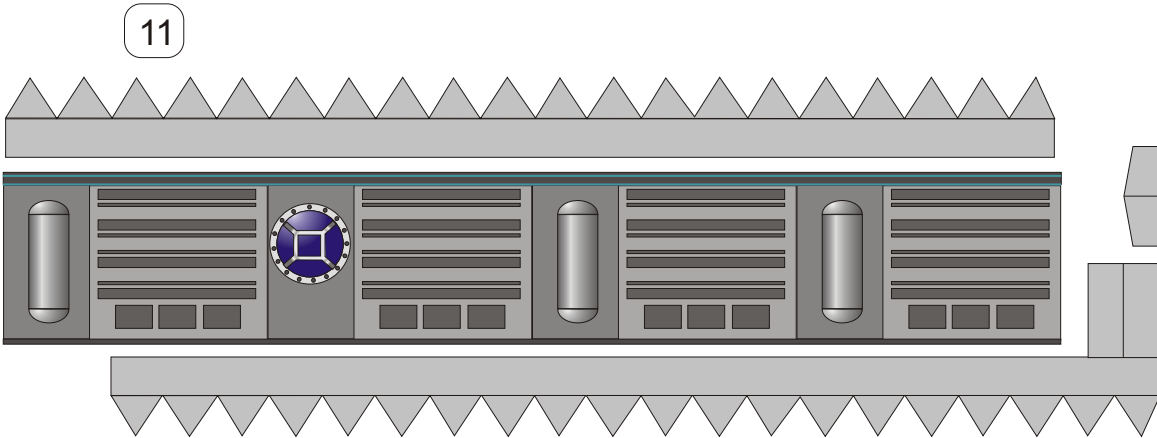
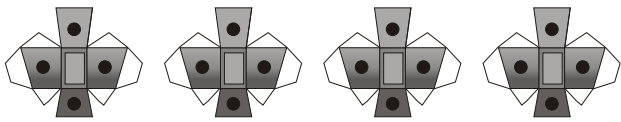
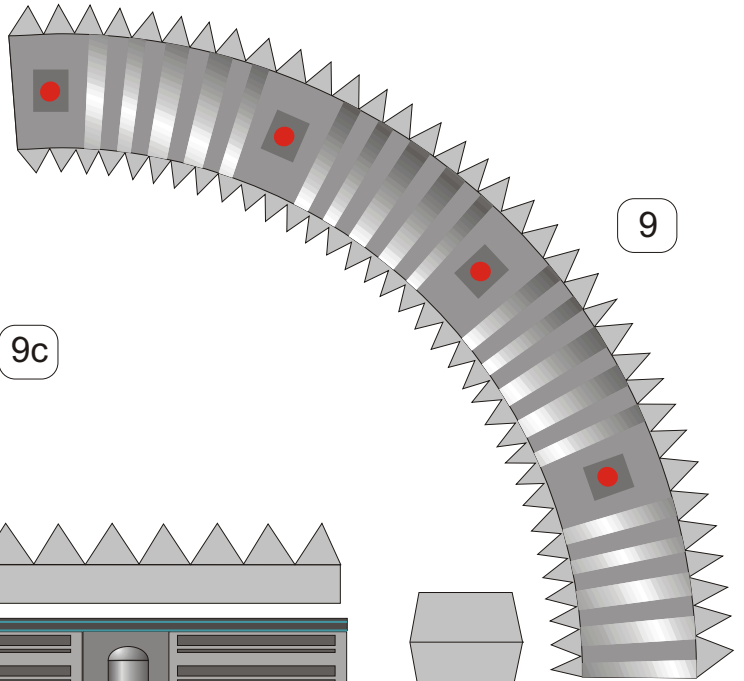
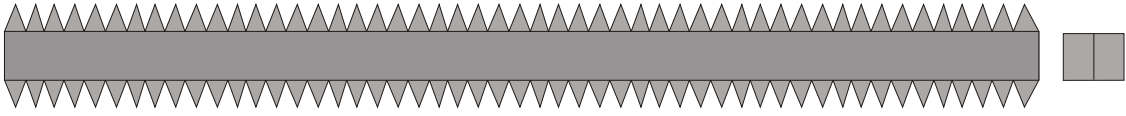
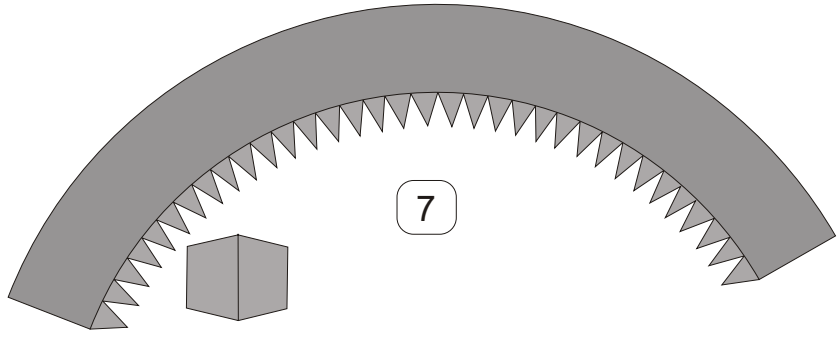

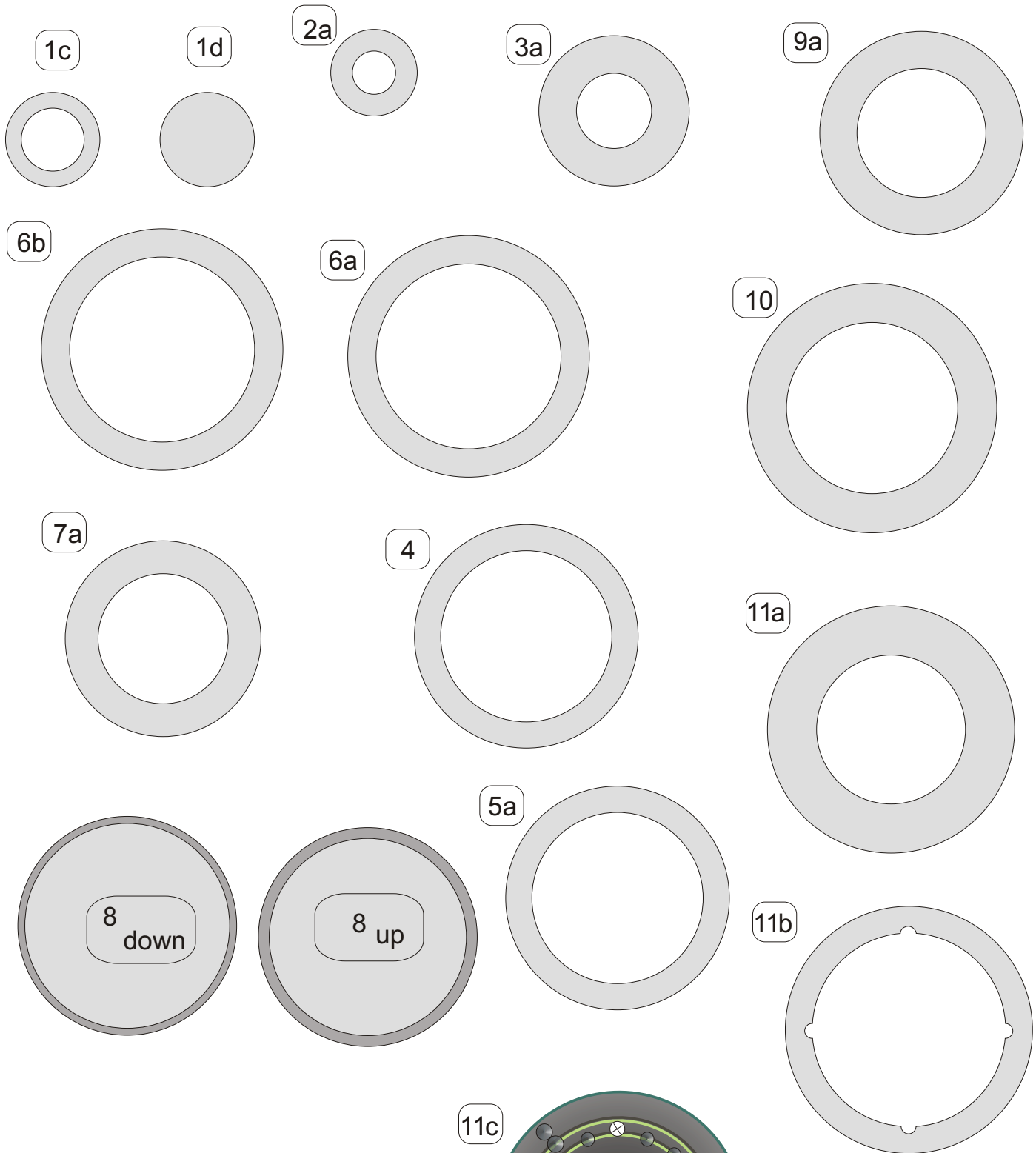

Laminate parts **4, 8-up, 8-down** and **10** to a total thickness of about 0.8 to 1 mm. After cutting glue parts **8-up** and **8-down** by backsides. Glue edges over with "silver" strips.

The rest parts glue onto the same paper.

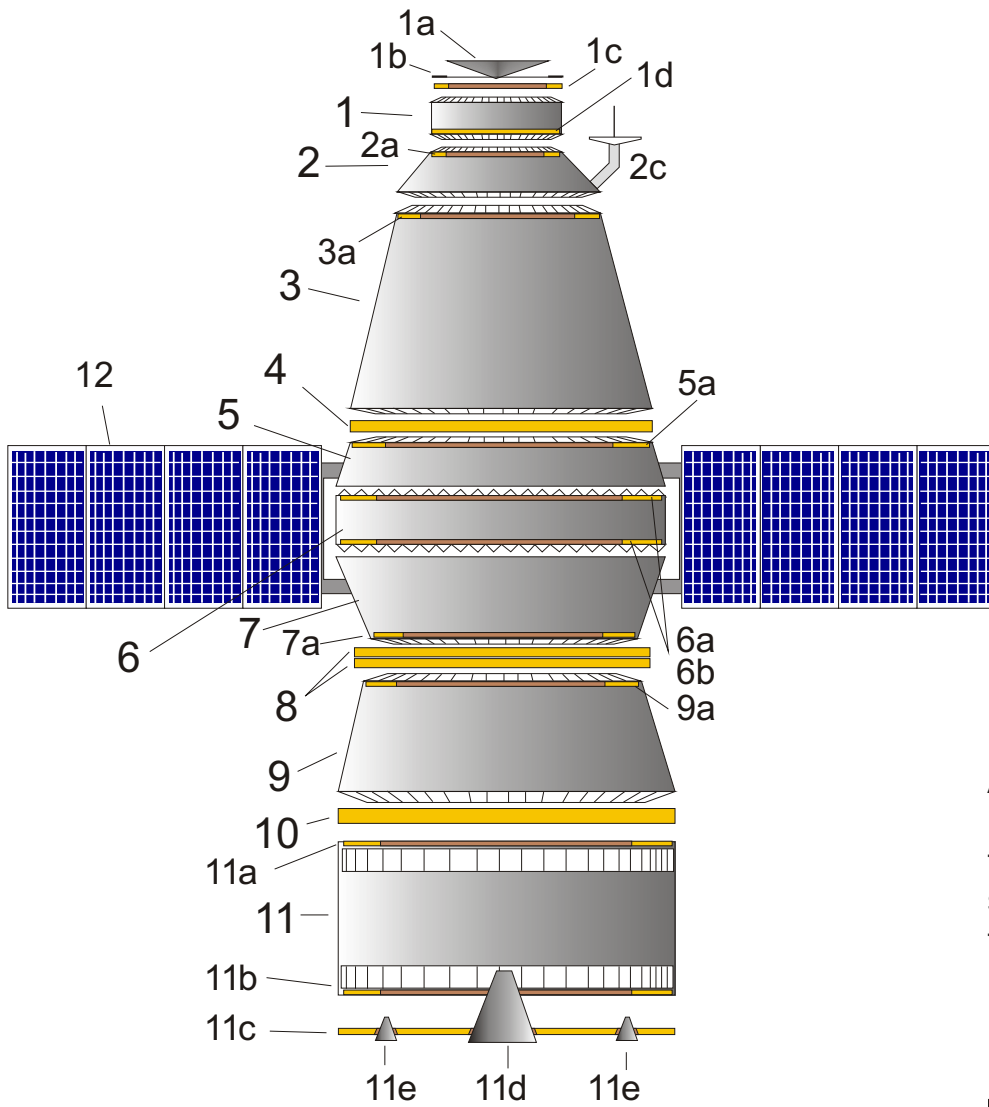

As an option it would be recommended to cut the solar panels on separate blocks and glue these using thin flexible plastic strips.

