

# Angara 5

www.cardmodels-r.narod.ru

1:96 scale

The **Angara rocket family** is a family of space-launch vehicles currently under development by the Khrunichev State Research and Production Space Center. The rockets, which are to provide lifting capabilities between 2,000 and 40,500 kg into low earth orbit, are intended to become the mainstay of the Russian unmanned launcher fleet in the future and replace several existing systems.

The **Angara** rockets have a modular design similar to the EELV, based on a common Universal Rocket Module (URM). Depending on configuration, the first stage can consist of 1, 3, 5 or 7 such modules. Unlike EELV launchers, **Angara** will not employ solid rocket boosters (SRB).

The URM is a wholesome structure that includes an oxidizer tank, a fuel tank and a propulsion bay. Each URM will have one single-chamber RD-191 engine (Lox/kerosene). The RD-191 design is based on the RD-170 four-chamber engine used by the Energia launcher, as well as on the RD-171, which is currently used by the Zenit rocket.

The first stage of **Angara 5** can consist of 5 URM.

The second stage will be Block I (also called URM-2), which is powered by the RD-0124A engine. **Angara 5** will use the Breeze-M upper stage (currently used for the Proton-M rocket) or KVRB (Lox/LH2).

Most versions are intended for unmanned launches, but **Angara A5P** and **Angara A7P** are being designed to be capable of launching manned spacecraft.

A single launch pad can be used for launching all **Angara** versions.

(from [http://en.wikipedia.org/wiki/Angara\\_\(rocket\\_family\)](http://en.wikipedia.org/wiki/Angara_(rocket_family)))

H ~ 580 mm

Paper used:

0,26 mm - 200 gr ("cardstock")

0,15 mm - 130 gr

Glue: PVA

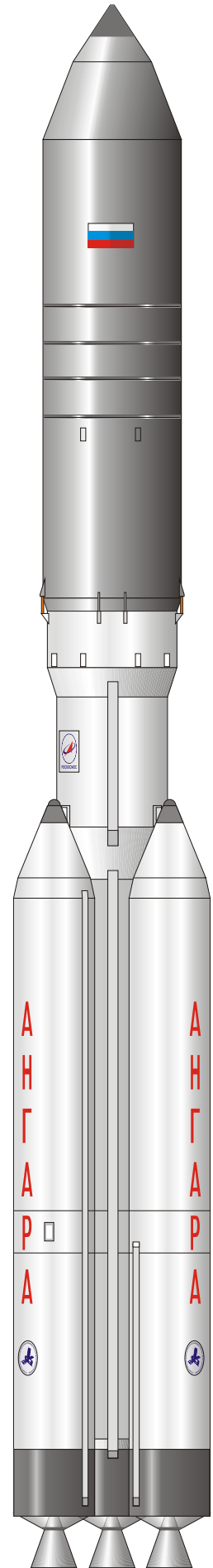

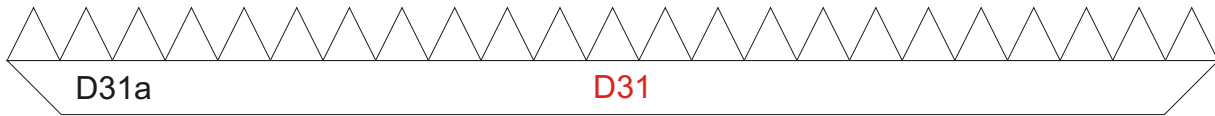
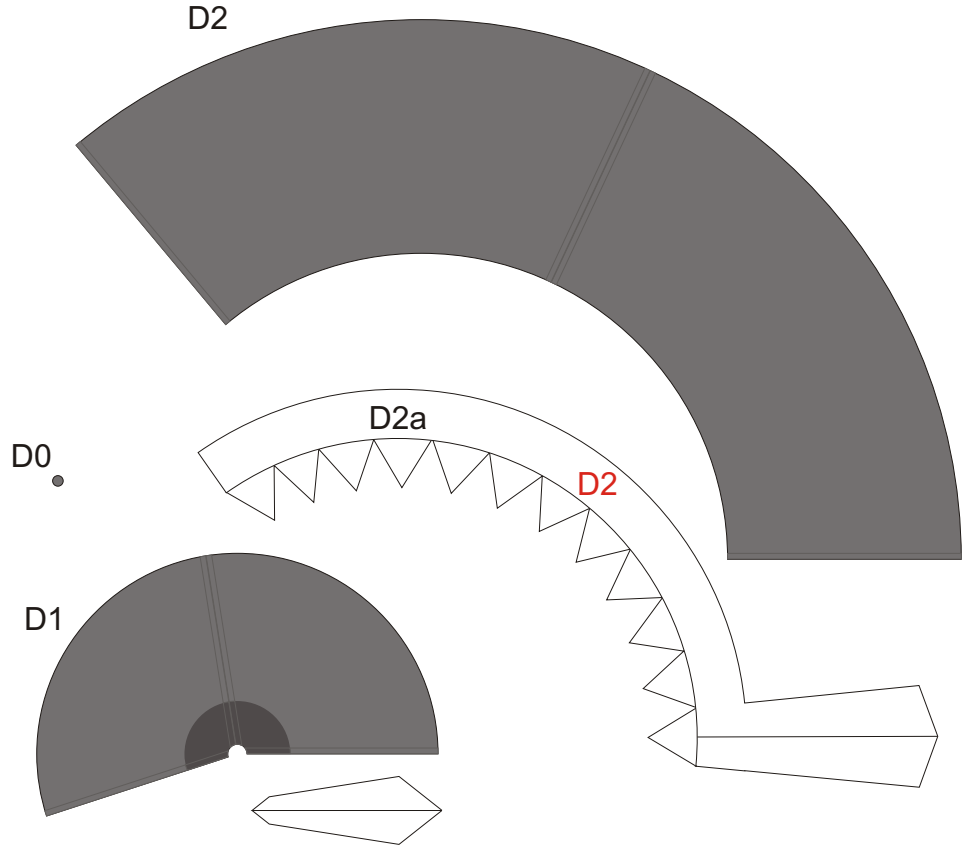
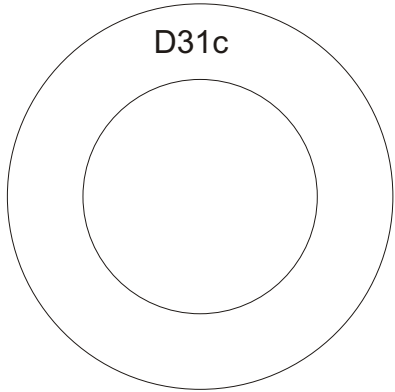
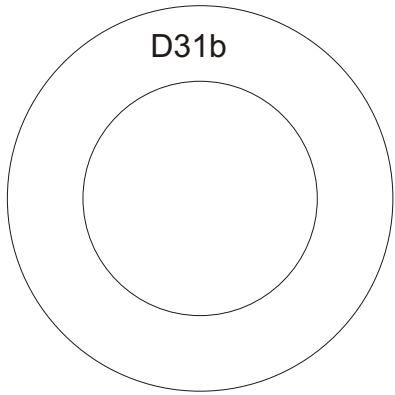

D31

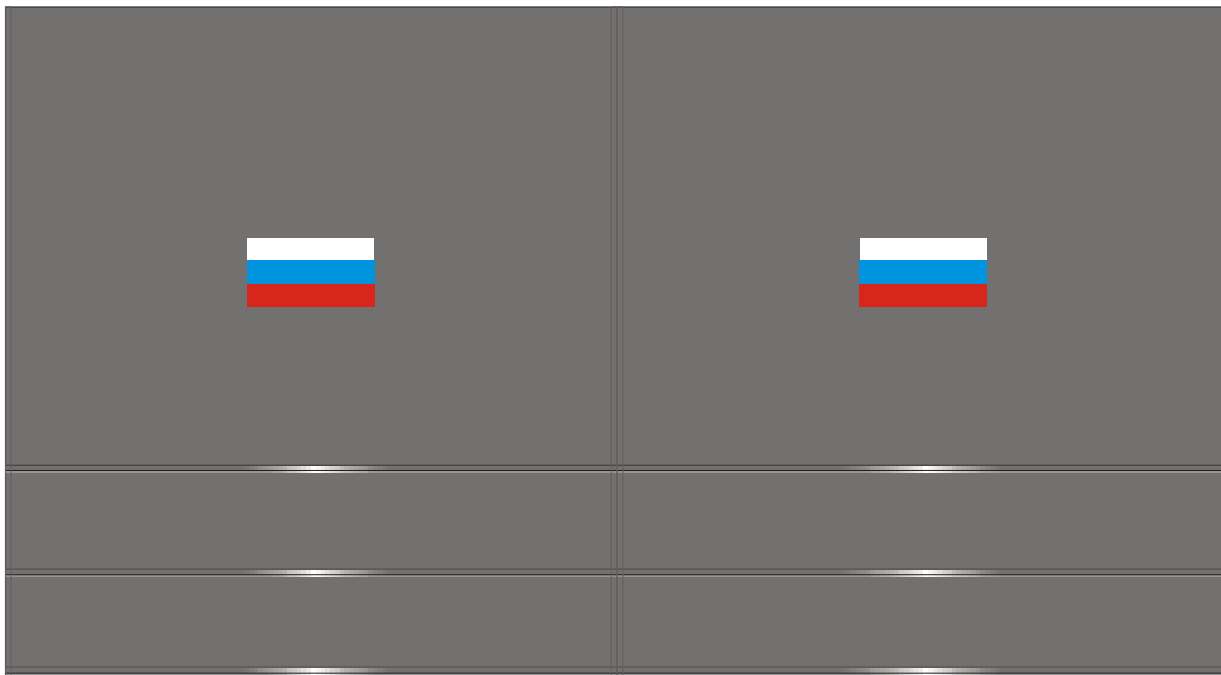

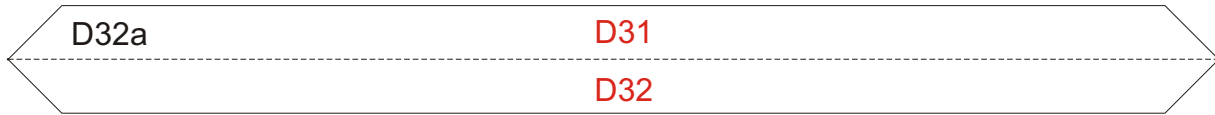

D32

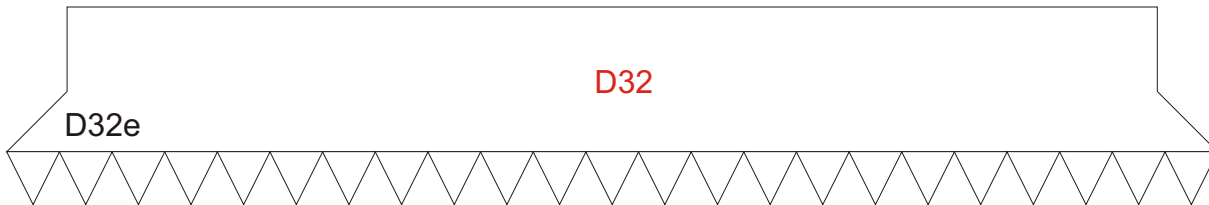
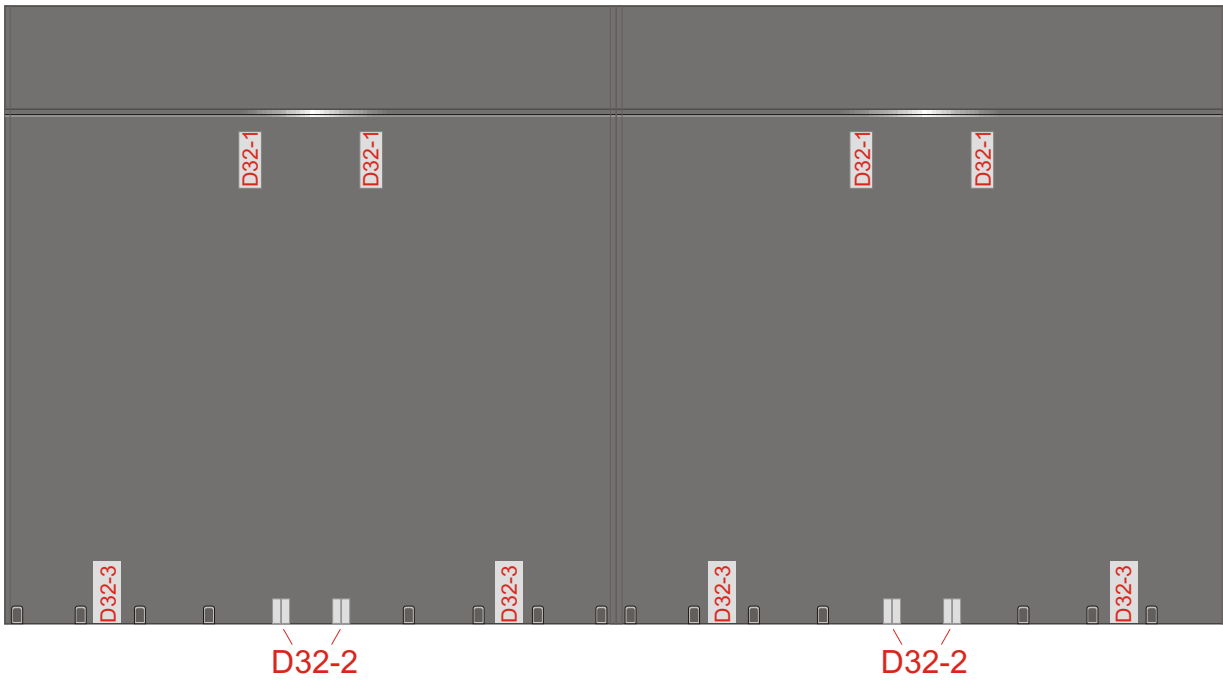

D32d

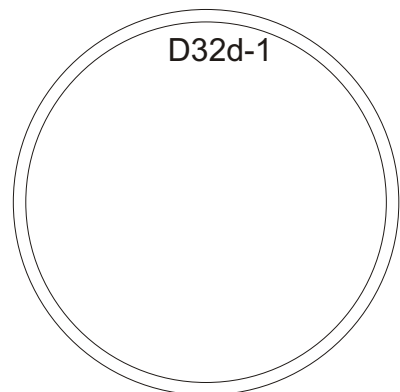
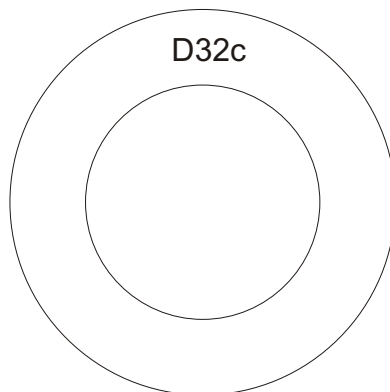
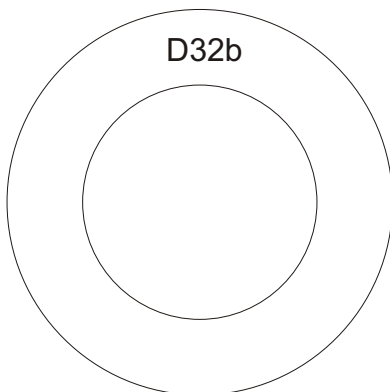
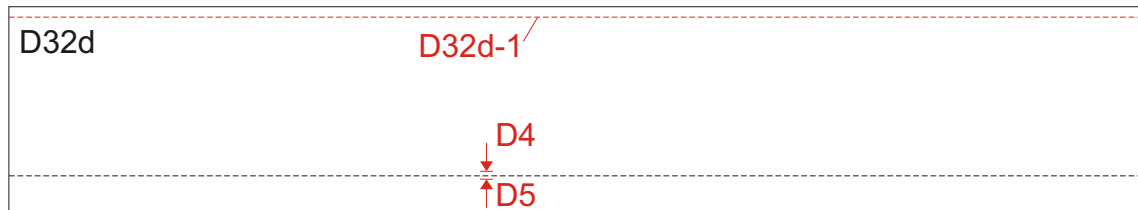

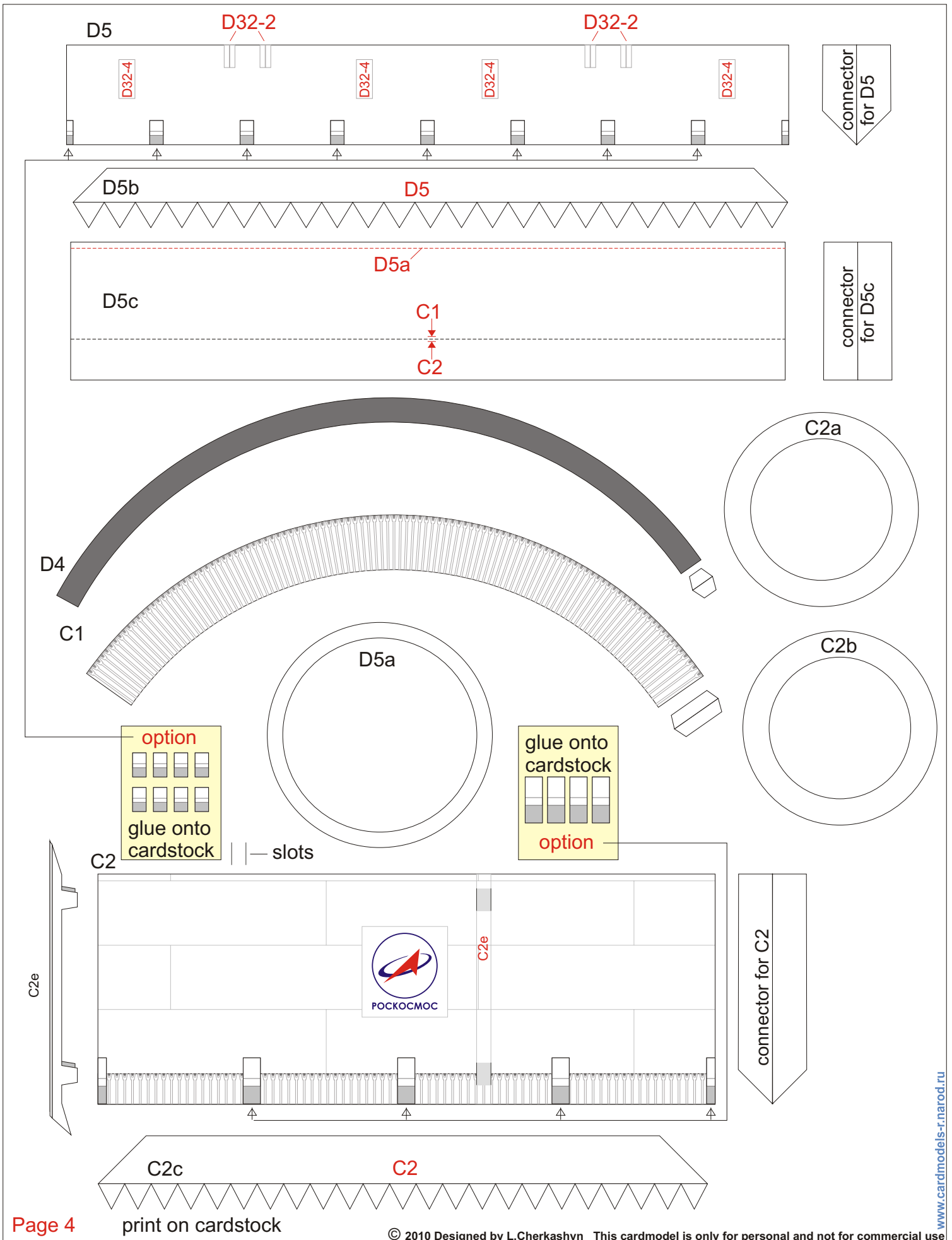

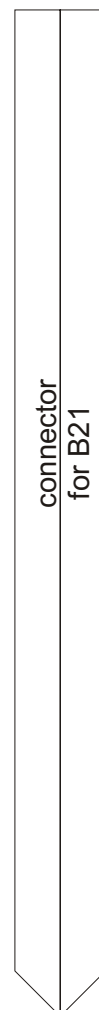
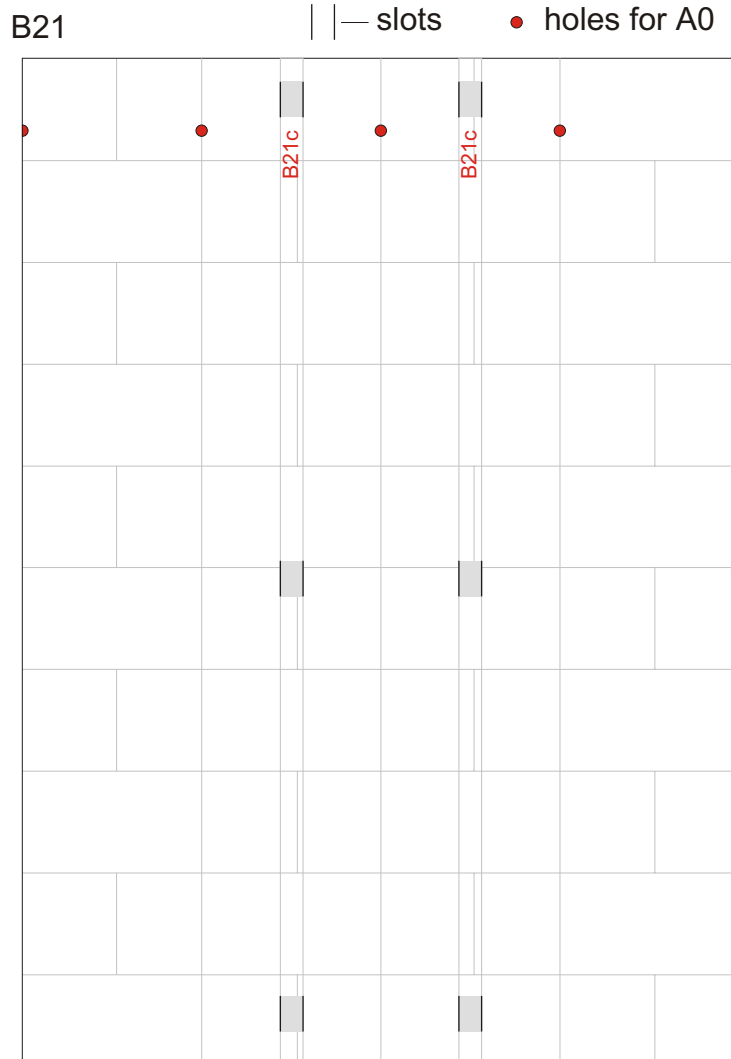
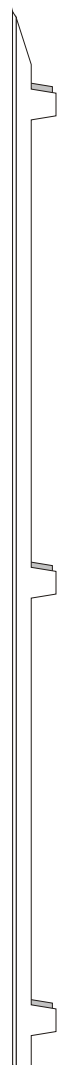
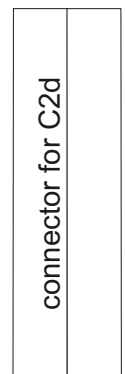
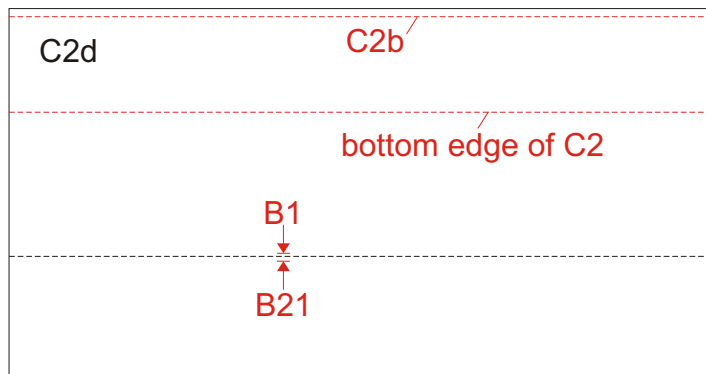
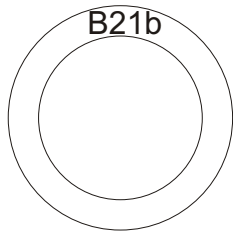
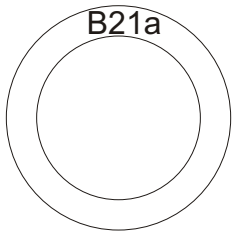
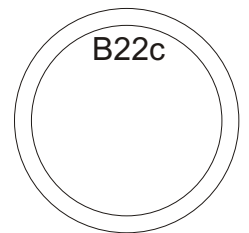
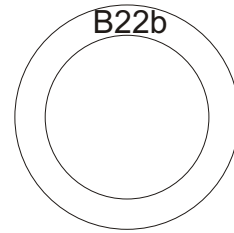
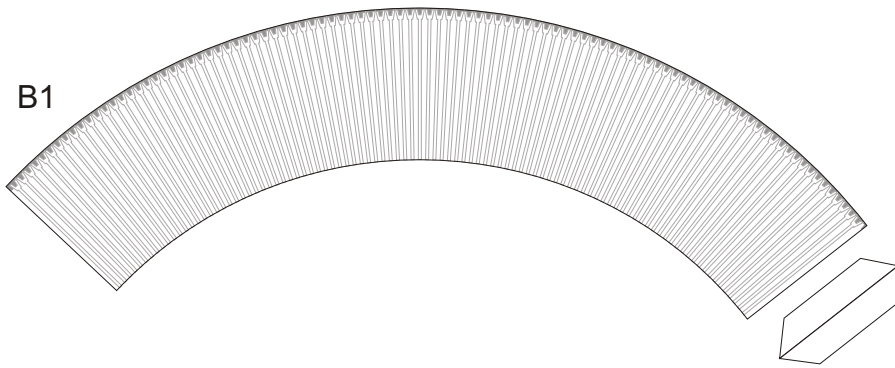

B21d

B22a B21 B22

||— slots

• holes for A0

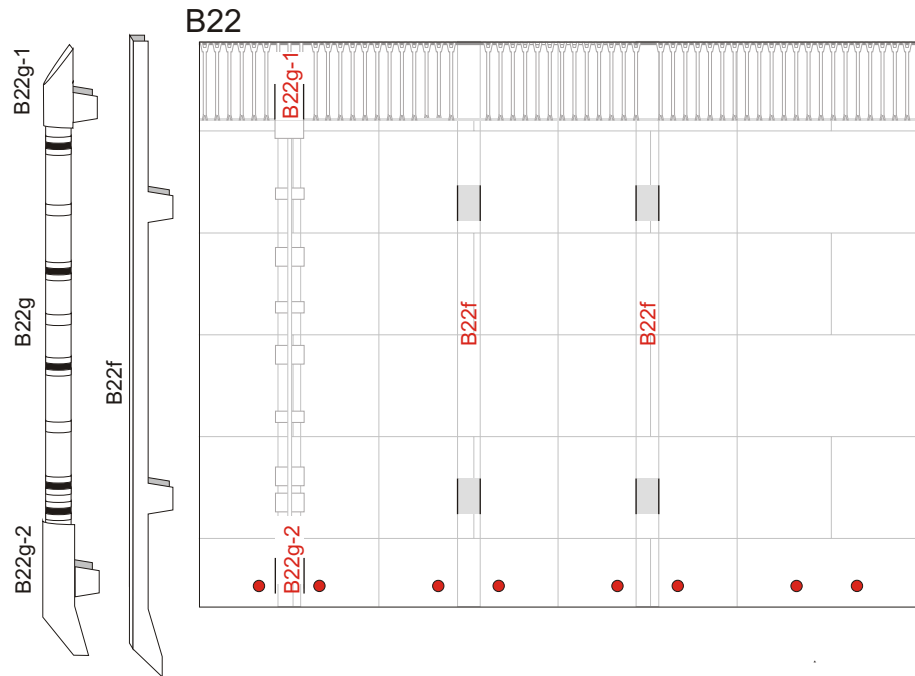

B22d B22

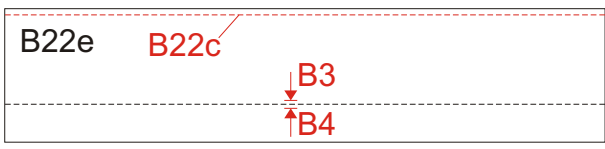
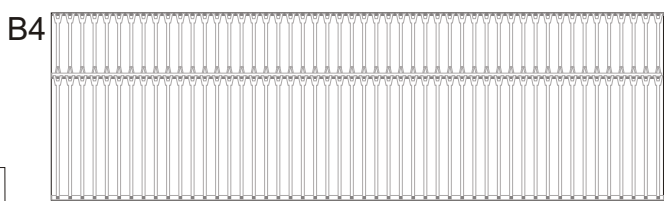

connector for B22e

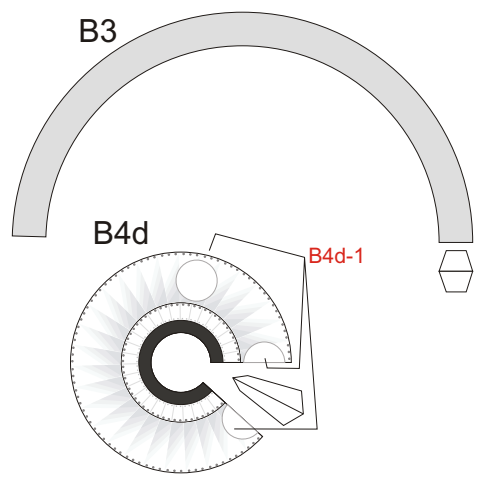
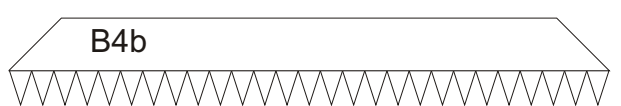

connector for B4

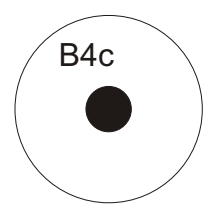
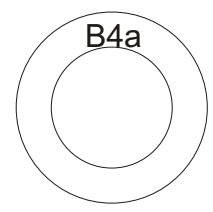
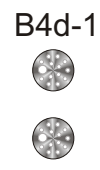

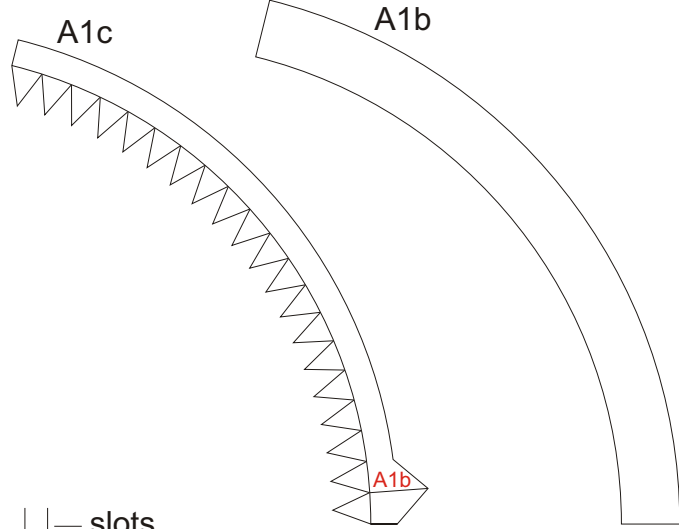
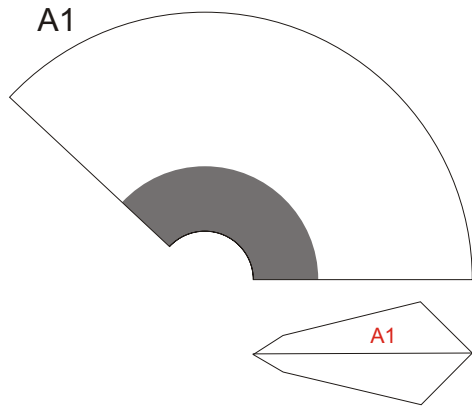

A1a  
d=4,5 mm



||— slots

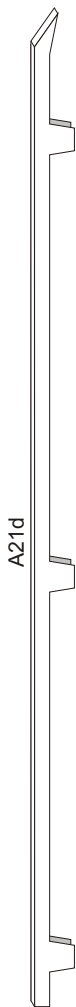

hole for A0

connector for A21

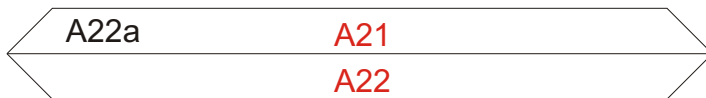
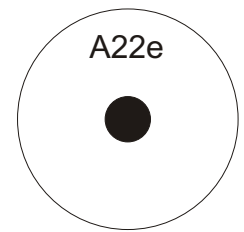
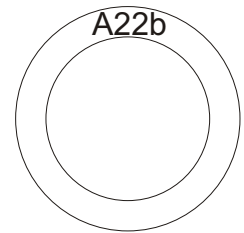
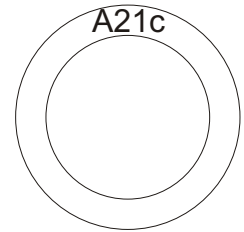
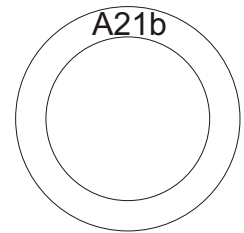

||— slots    • holes for A0

A22

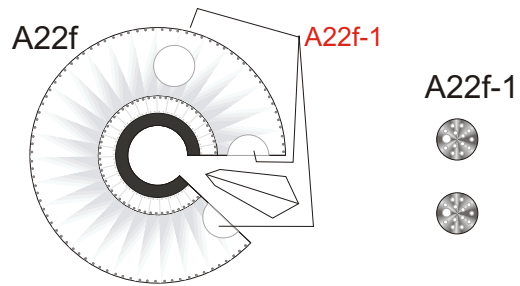
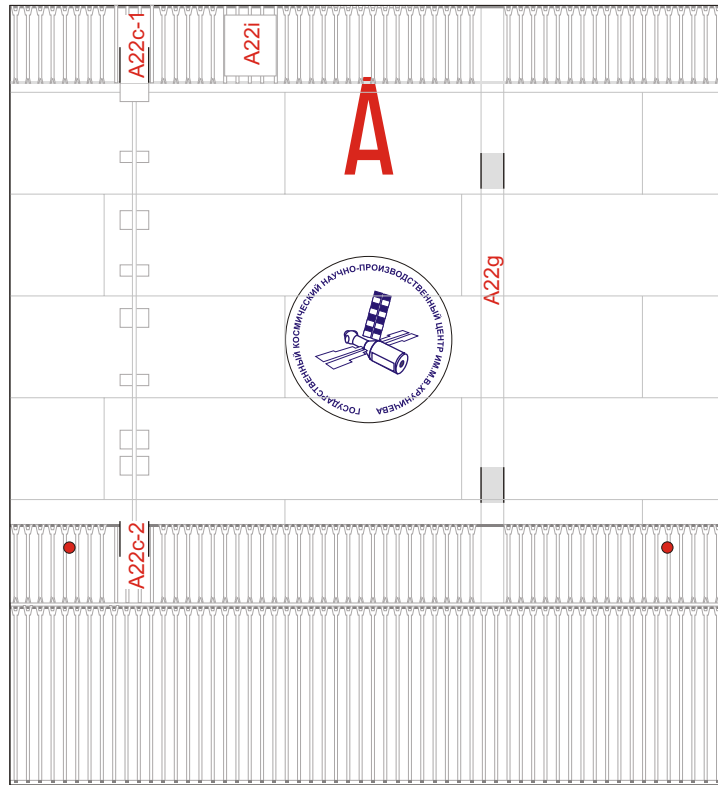
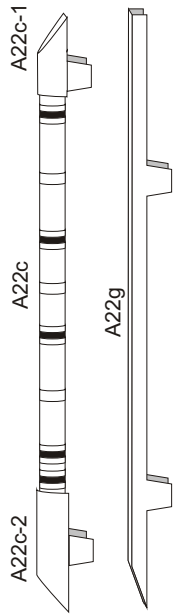



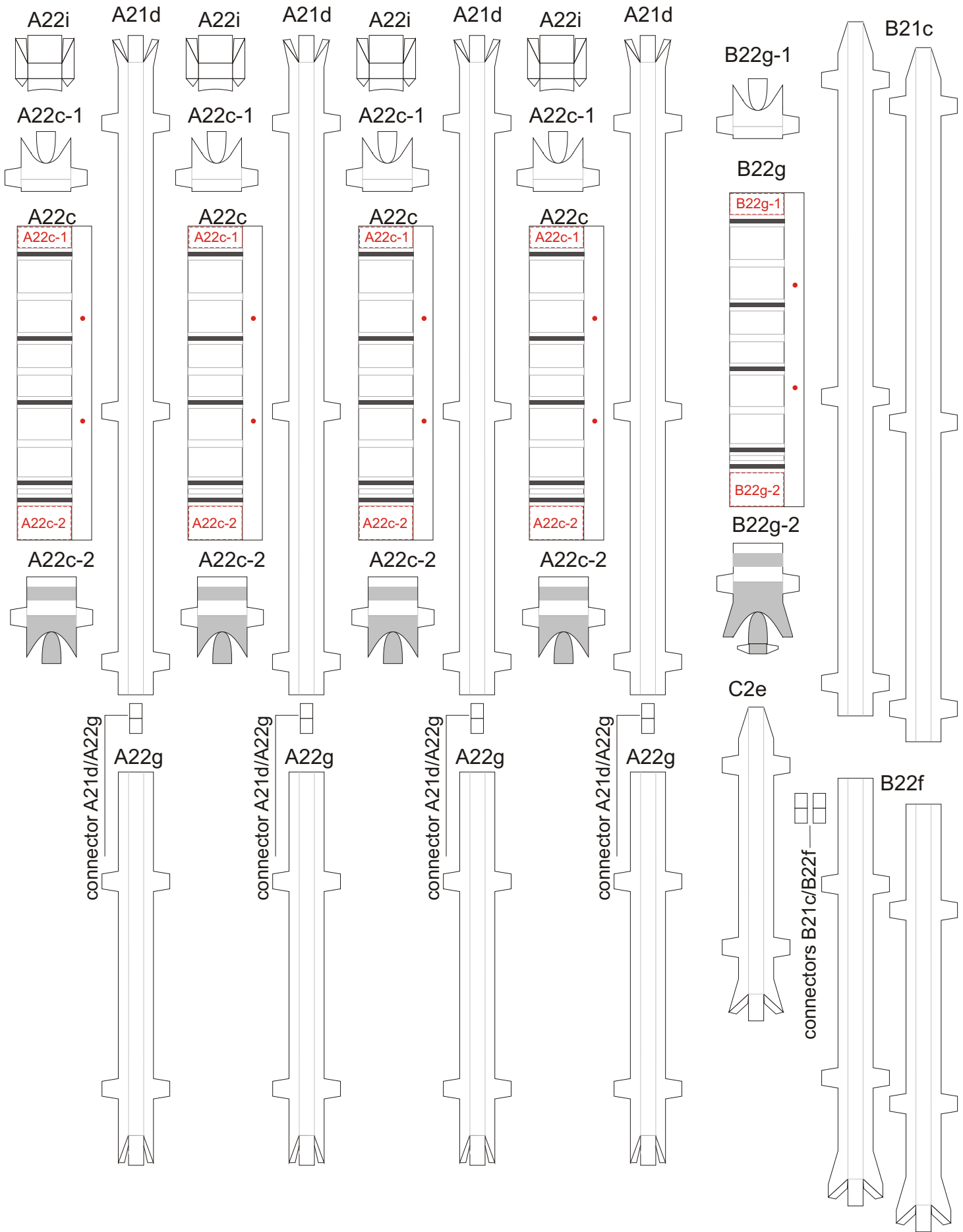

D32-2

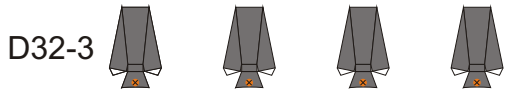
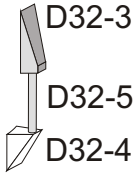
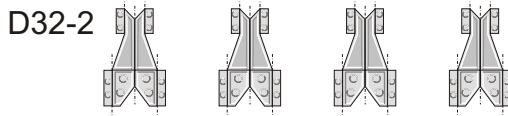
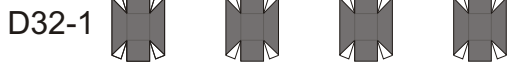

D32-5 (x 4)  
rod d=1 mm L=8 mm

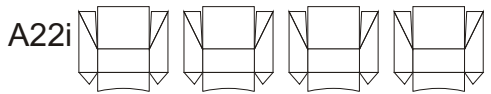

rods for  
assembling  
blocks of  
stage A  
with stage B

A0 (x 12)  
d=1,5mm  
L=10mm

spare

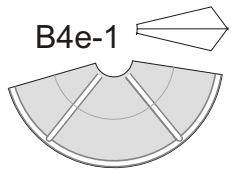
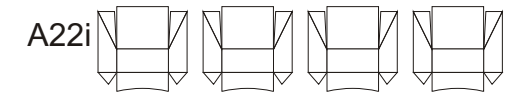
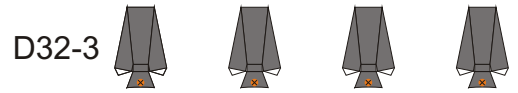
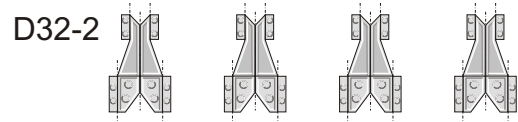

connector  
B4e-1 / B4e-2

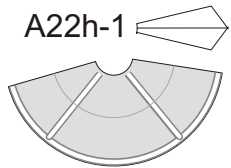
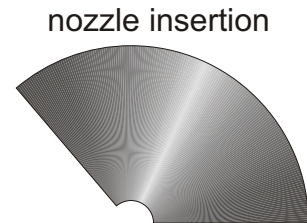

connector  
A22h-1 / A22h-2

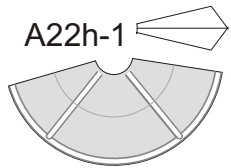
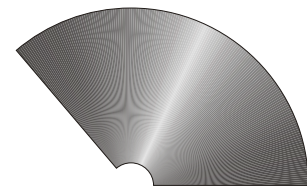
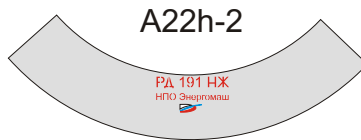

connector  
A22h-1 / A22h-2

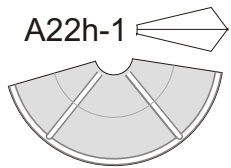
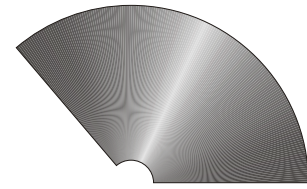

connector  
A22h-1 / A22h-2

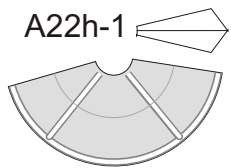
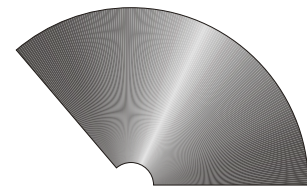

connector  
A22h-1 / A22h-2

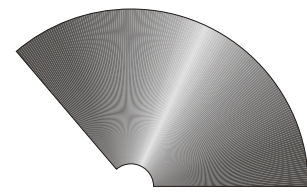

# Angara 5

## Assembly diagram

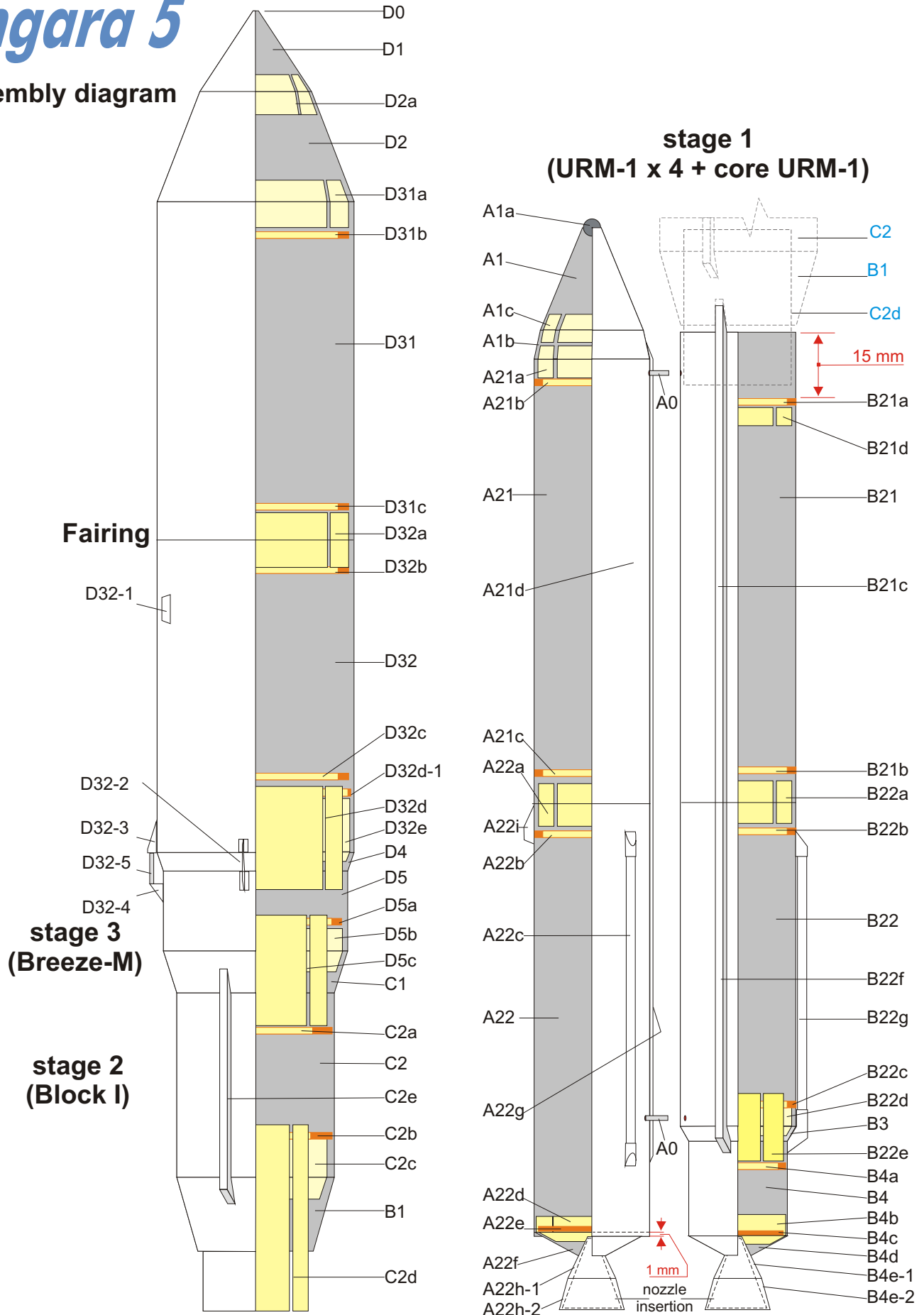

# Angara 5

Assembly steps of Fairing, stage 3 (Breeze-M), stage 2 (Block I) and stage 1 (core URM-1)

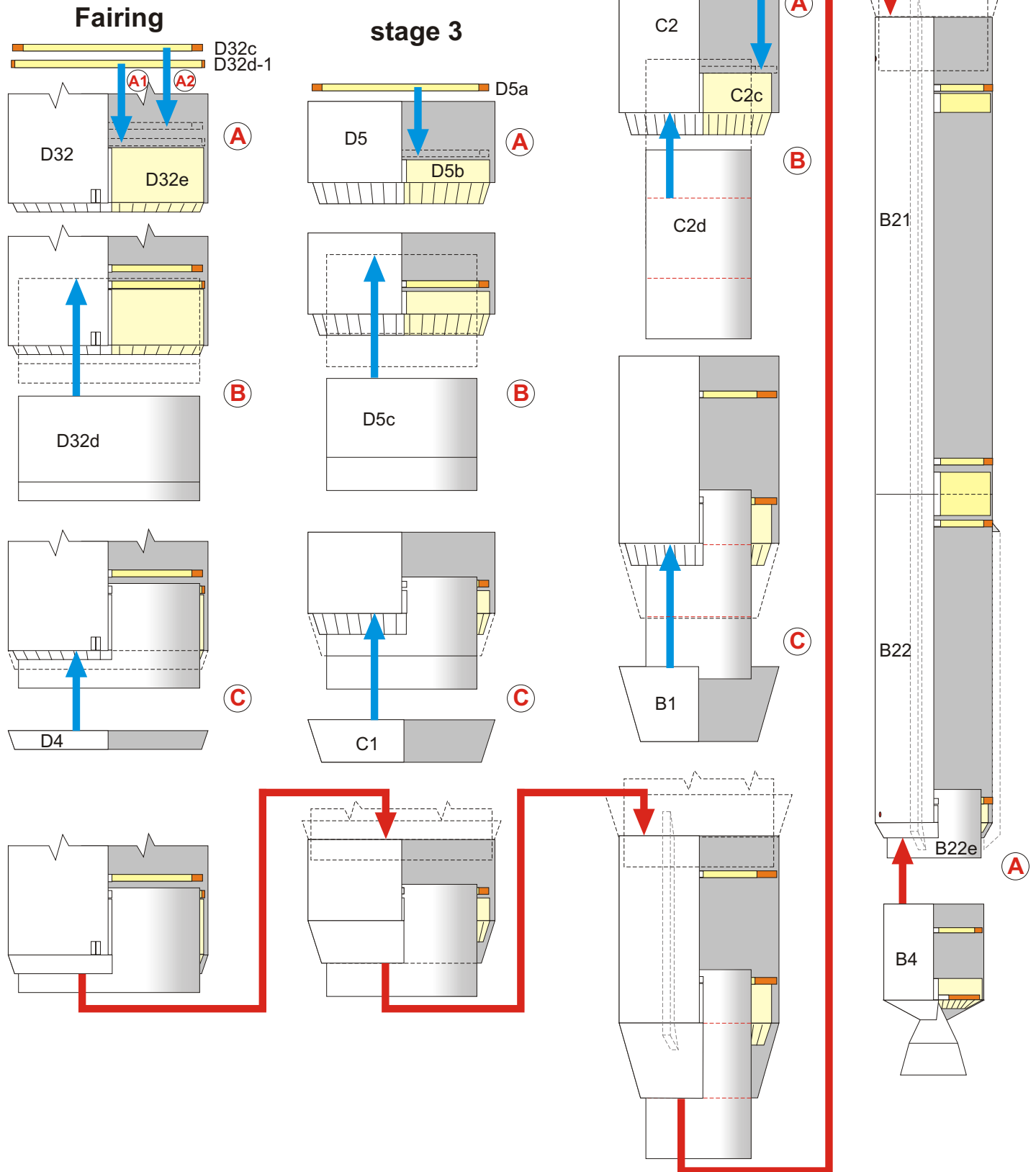

# Angara 5

1:96 scale

Top view

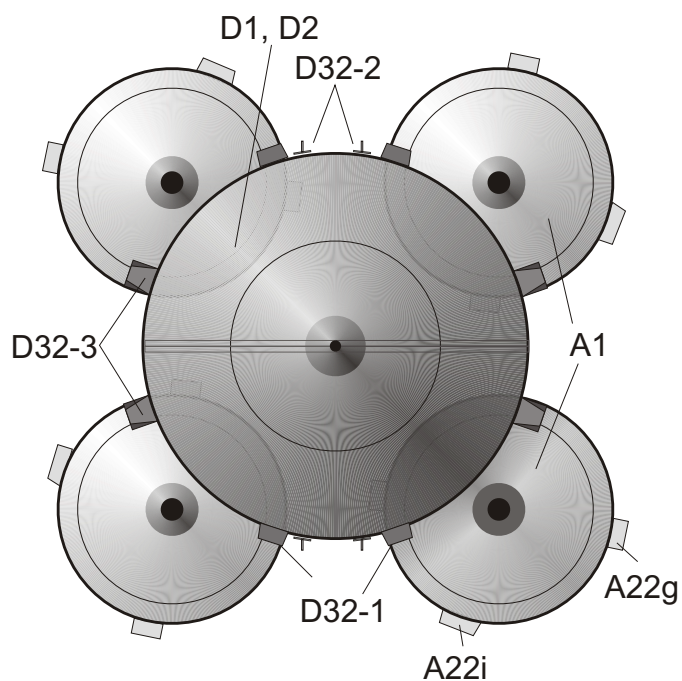

Bottom view

